

What Comes With Your Kayak?

1. Hull
2. Seat
3. MirageDrive (2 parts)
4. Rudder
5. Paddle
6. Cassette Plug

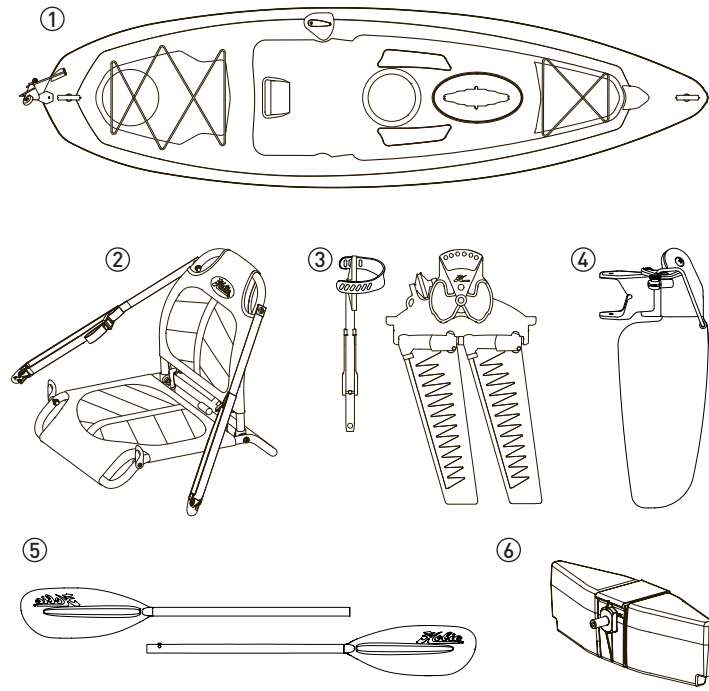

On the Water

Rudder Down

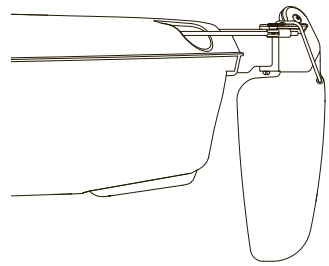

Rudder Up

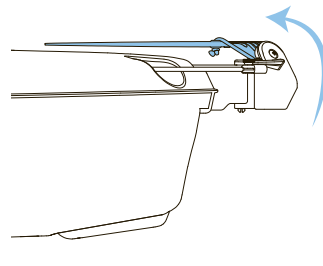

Steering

The steering handle is located in the middle on the left/port side of the kayak.

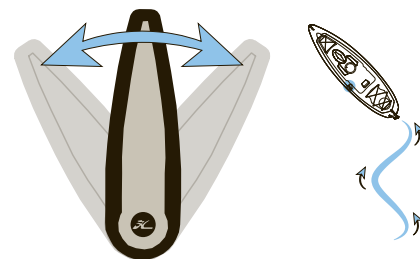

Paddle Assembly

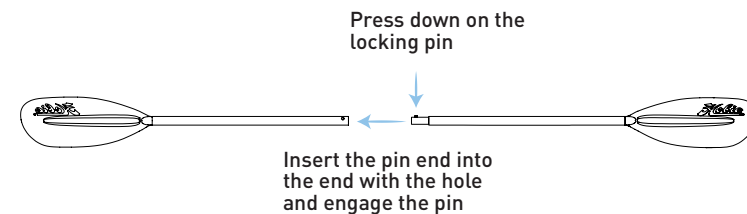

Pedal Adjustment

Adjust cranks by rotating and clicking them into the desired position. Make sure both cranks are in the same position number.

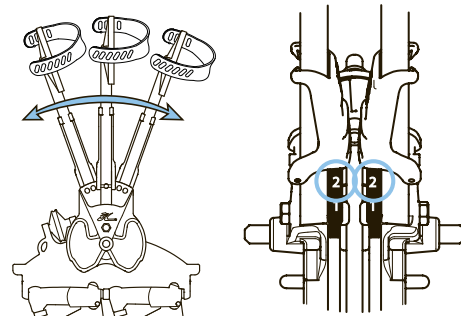

With both feet on the pedals and together (fins straight down), your knees should be comfortably bent and not crunched or over extended.

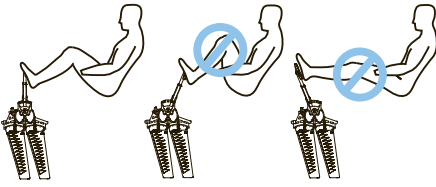

Seat Adjustment

To adjust, pull down on loop of straps for less recline in the seat. For more recline, release the tension in the strap.



MirageDrive Operation

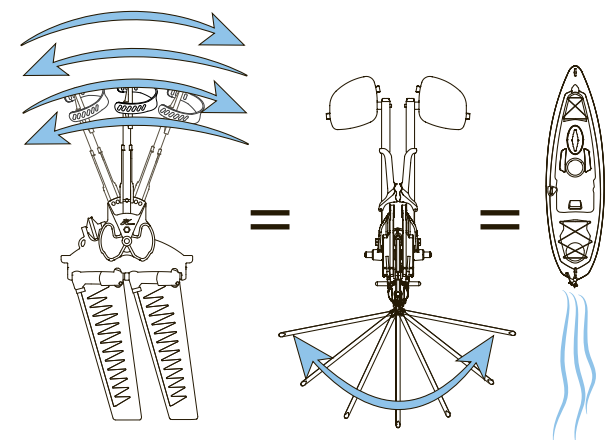

Shallow Water and Beaching



Press either pedal forward in shallow water to raise fins. Pressing one pedal fully forward will orient the fins with the kayak underside to allow beaching.

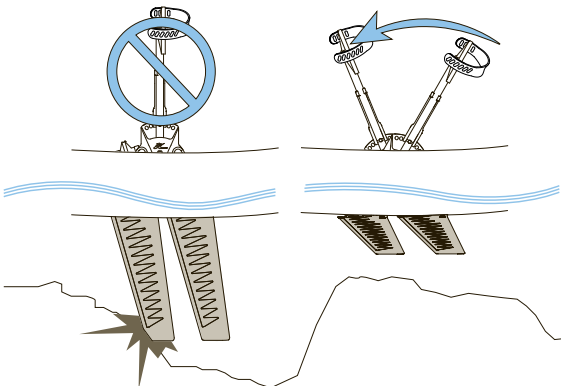

Storage and Transport

Storage Do's

Place your boat upside down on crossbars or hang from wide strapping are recommended ways for proper storage.

Storage Don'ts

Storing your boat cockpit side up on crossbars can dent the bottom.

Storing your boat on its side over a long period of time can flatten/dent the sides.

Hanging the boat by the scuppers can distort the scupper holes.

Never hang the boat by handles or pad eyes. They are not designed to handle long-term load and will fail.

Never use PVC runners or tubes to store boat on.

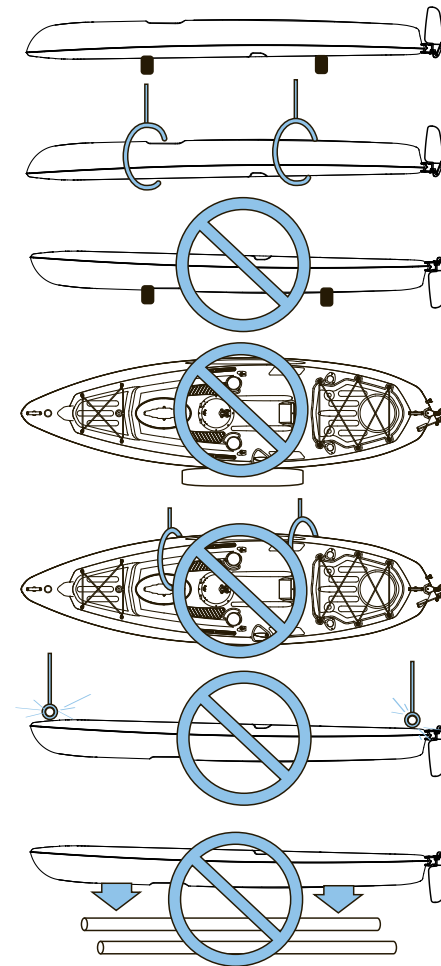

Additional Storage Key Points

- Always remove all water from boat
- Don't leave tie-down straps tight over a long period of time
- Storing in non-recommended configurations can result in hull damage and can void your warranty

Roof Topping

The best way to transport your boat is to purchase a trailer or roof rack from your dealer. Using proper cradles that support the hull, the boat can be transported right side up. Straps can then be laid across the boat and tied to the rack bars. Straps should be tight, but not so tight that they distort the shape of the boat. Avoid using ratchet straps to prevent overtightening.

Be sure to consult your car and roof rack owner's manual to ensure that you comply with all recommendations, precautions and specifications.

Running a line or strap from the bow and stern of the boat to each bumper is required. If your bumpers do not have a gap to pass a rope around, look underneath. There should be a loop of metal, which is used by car transports such as tow trucks.

Many people like to use the scupper holes to tie the boat to the car. This helps prevent the boat from sliding back and forth or the tie-down rope from slipping off the boat. (This is an acceptable method for tying the boat down for transport.)

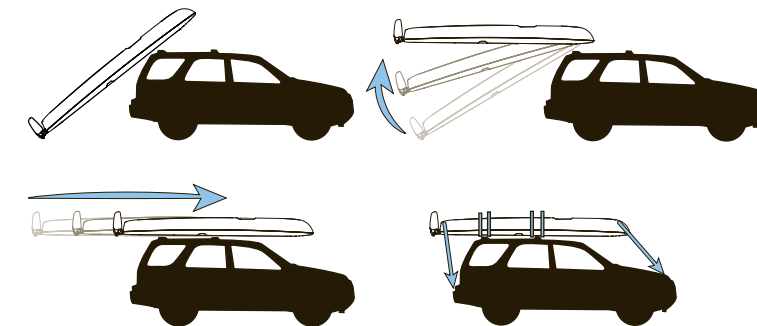

Maintenance and Care

MirageDrive Regular Maintenance

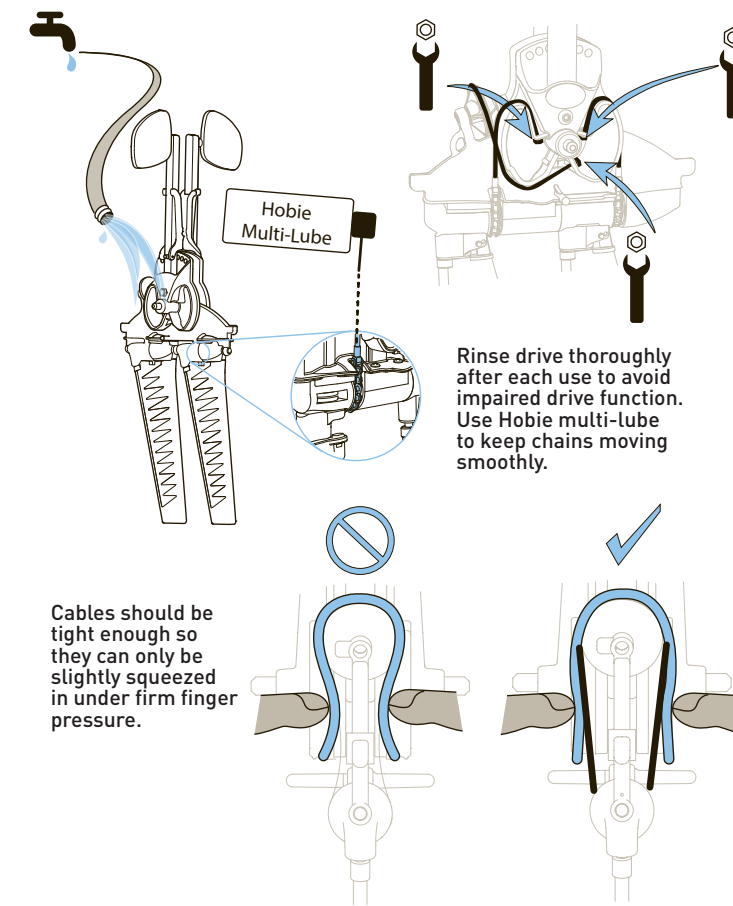

Cables should be tight enough so they can only be slightly squeezed in under firm finger pressure.

Warranty

It is very important that you complete and send us your Warranty Registration Card as soon as possible.

This information enables Hobie Cat Company to contact you should there be important product information that needs to be shared with you in a timely manner. Please complete the Warranty Registration Card in your Owner's Packet, or take advantage of our online option at:

<http://www.hobie.com/product-registration>
or

Scan this QR code with your smart phone



If you have a question or issue with your Hobie product, please see your Authorized Hobie Kayak Dealer. They will assess the problem, assist with a repair and file a warranty claim with Hobie Cat Company, if needed. All warranty claims must go through your Authorized Hobie Kayak Dealer. The Warranty Registration Card and Warranty Policies are included with each model in the Owner's Packet. Type in the address below to go to our dealer finder webpage.

All specs, colors, graphics and features are subject to change without notice. Please refer to the website for complete details.

<http://www.hobie.com/dealers>

Safety

Checklist

Please read through the owner's information package prior to using this product. The user of this product acknowledges both an understanding and assumption of risk involved in paddle/pedal sports. Consult your physician prior to beginning.

Always:

- Wear a Coast Guard approved personal flotation device (lifejacket).
- Dress appropriately for weather conditions; cold water and/or weather can result in hypothermia; apply sunscreen and wear sun protective clothing.
- Check your equipment prior to each use for signs of wear or failure.
- Secure a safety leash to your paddle and MirageDrive®.
- Scout unfamiliar waters.
- Be aware of river water levels, tidal changes, wind conditions, obstacles in and above the water and weather changes.
- Always make sure that your hatches are secure and closed.
- Carry a pump and/or bailing device. Always carry the spare paddle provided with the boat.

Never:

- Never go alone and always file a float plan.
- Never go in flood and/or fast moving water conditions. Hobie kayaks are not designed for fast moving water.
- Never exceed your ability and be aware of your limitations.
- Never use alcohol or mind-altering drugs prior to or while using this product.
- Never open your hatches in unstable water conditions.
- Never remove the foam pieces inside the hull. They are installed for structure, additional flotation and safety.

Getting into your Boat

If you fall out of your boat, stay with the boat. You should be properly wearing a life jacket/PFD which will keep you afloat. If the boat is upside-down, it will need to be turned over. To do this, reach across the bottom of the boat and grab the scupper hole or the Hobie MirageDrive and pull the boat upright. Position yourself so your head is near the cockpit area of the boat and you are facing the boat. You will want to be between the seat and the footwell areas of the boat. Reach across the boat to the far edge with one hand. Place the other hand on the near-side rail, then kick with your feet, pulling yourself up and onto the boat. Roll over onto your backside toward the seat, which should place your backside in the seat. Sit up, swing your feet into the footwells and you're ready to go.

Shakedown Cruise

As with any new product, it is important that you become familiar with the boat and all its features. It is also important to determine that the boat is sound before long trips. We recommend that you do what we call a "shakedown cruise" when the boat is new, after shipping or transport, before long trips and after installing any thru-hull fittings. This test is typically done in shallow, calm conditions where you can familiarize yourself with or test the boat before taking any long trips into open water. Things you should check or practice are:

- MirageDrive installation, adjustment and removal
- Rudder operation
- Closing hatches properly
- Drain plug locations to make sure they are properly installed
- Getting in and out of the boat from a capsized state
- Taking the kayak sail down on the water (if applicable)

Mirage Kayak Cassette Plug

Your Hobie is shipped with a Mirage Cassette Plug. The plug is provided as standard equipment in the Mirage Kayak package. Insert the plug into the Mirage well when the MirageDrive is removed to provide added safety and to "fair" the bottom of the hull when paddling.

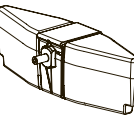

Hobie Cat Company

Holding Company
Oceanside, California, USA
1-800-HOBIE-49

Hobie Cat Australasia

Subsidiary
Huskisson, New South Wales, Australia
1-800-4-HOBIE

Hobie Cat Europe

Subsidiary
Toulon, France
+33 (0) 494 08 78 78

Hobie Kayak Europe

Independent Distributor
Stellendam, The Netherlands
+31 (0) 187 499 440

Hobie Cat Brasil

Independent Distributor
Porto Belo, Santa Catarina, Brazil
+55 (21) 3942 6815

[hobie.com](http://www.hobie.com)

PN 77800080
REV 190306



Hobie® Mirage®
Passport Manual

Follow these steps to complete the basic set up of your new Hobie Mirage Passport!

Make sure to watch this **Quickstart Video** before using your Hobie product.

www.hobie.com/quickstart/passport10.5

TOOLS NEEDED:

phillips head screw driver



9/16" wrench



1 Drive Assembly

- Squeeze the crank adjusters to move the locking pin out of the way.
- Insert the cranks into the drum while still squeezing the adjusters.
- Once both cranks are in place and aligned with the bolt holes, fasten them to each side of the drum with the hex head bolts and a 9/16" wrench.

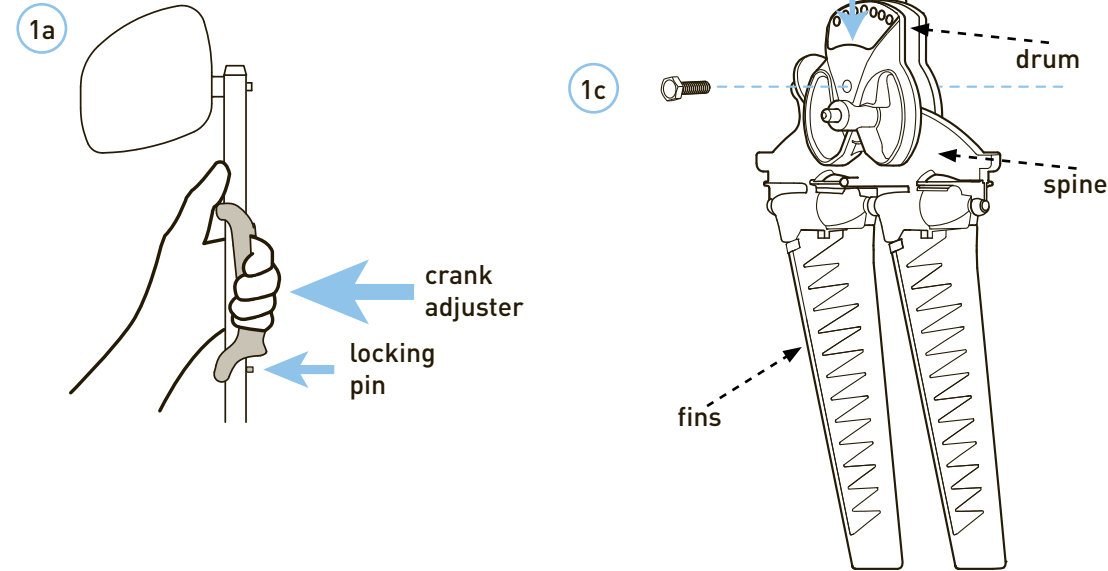

2 Drive Installation

- Lower drive straight down into well, making sure the spine is level. With a swift push downward, the drive will lock into the well automatically.
- Double check the Click and Go levers are pushed toward the bow and in the locked position before pedaling.

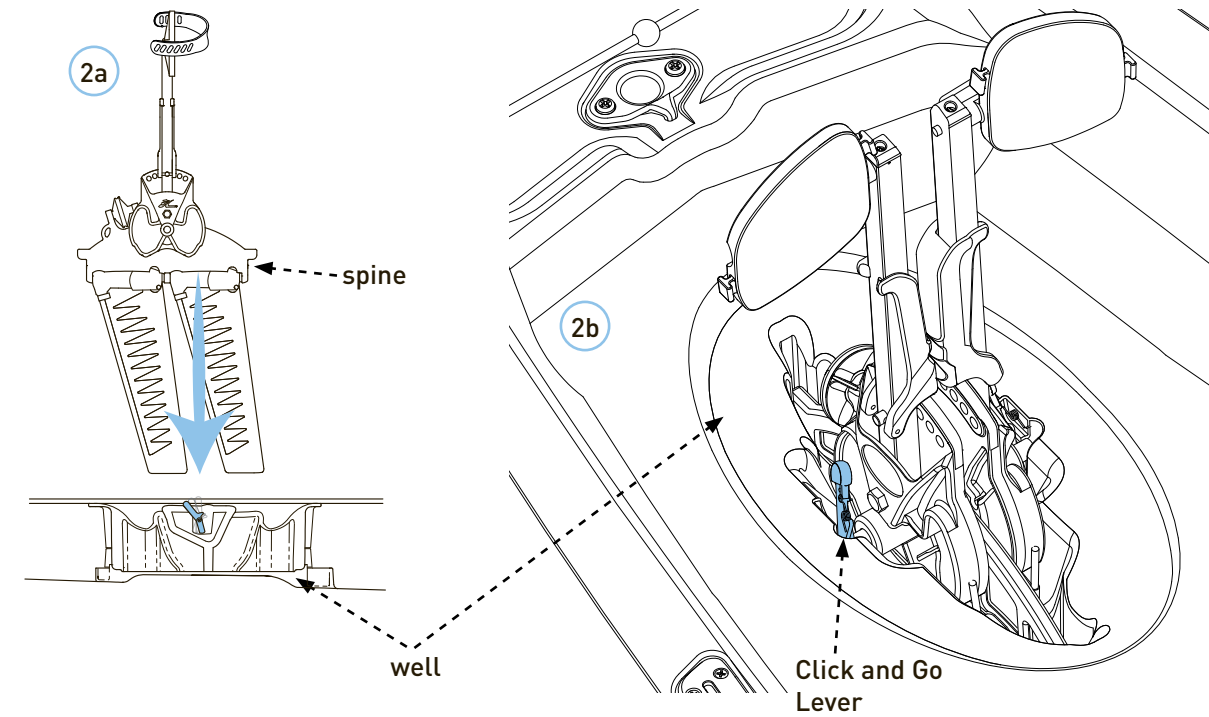

Drive Release

- To release the drive, pull each Click and Go lever towards the user and pull the drive straight up.

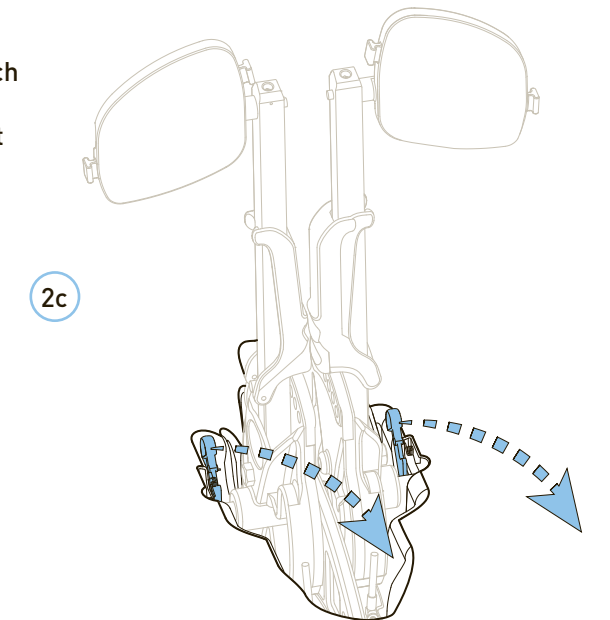

3 Rudder Installation

- Fasten the rudder to the inserts in the recesses at the back end of the kayak. Insert the steering rod into the rudder pivot and secure by tightening the adjustment knob.
- To adjust, center the steering handle and tighten the knob over the rod, by turning clockwise.

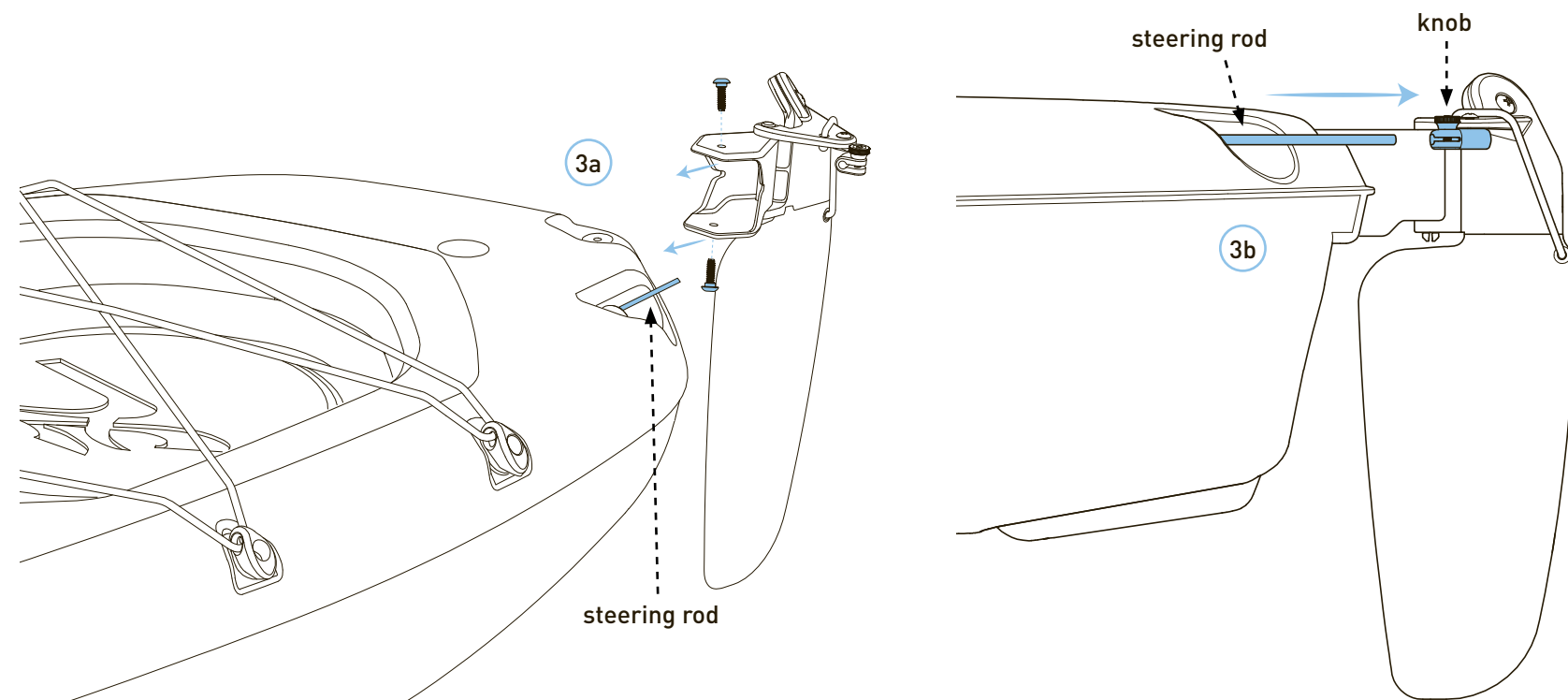

4 Seat Installation

- Place the seat in the kayak so the bottom of the seat frame rests in the channel at the rear of the cockpit and atop the raised seat platforms at the front. Lock the seat into place by turning the knob lock over the seat frame.
- Extend the seat straps forward and clip them to the pad eyes fixed to the hull.

