

Hobie® Mirage®
Pro Angler Manual



In 1950, Hobie's dream was born in his parents' garage when he decided to apply his love of woodworking to the sport of surfing. Dad backed out the Buick... Hobie carved out his very first surfboard...

Hobie's business of fun had begun.

Anatomy	5
Assembly	6
MirageDrive®.....	8
Vantage Seating.....	10
On the Water.....	14
Lowrance Ready Option.....	17
Storage and Transport.....	20
Maintenance and Care	23
Safety.....	25
Warranty.....	27



Look for this icon. Online video is available at
www.hobiecat.com/support/products/pro-angler-12/

Please read through the instruction manual before using this product

1. Hull
2. MirageDrive
3. MirageDrive Seal
4. Vantage Seating
5. Paddle and T-Handle
6. Mirage Well Scupper Plug
7. Gear Bucket
8. Steering Handle Parts
9. Tackle Management Rack
10. Lowrance Ready Components

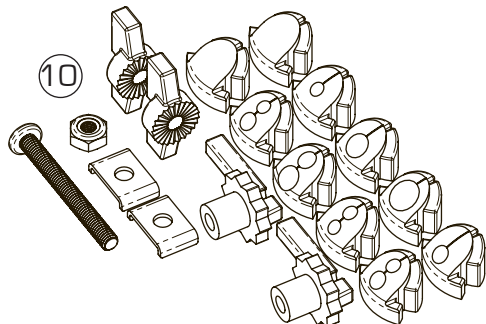
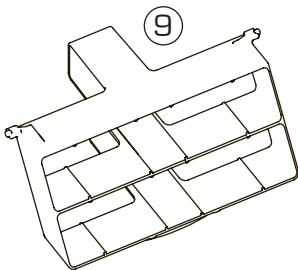
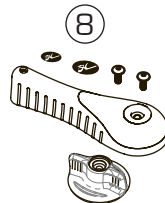
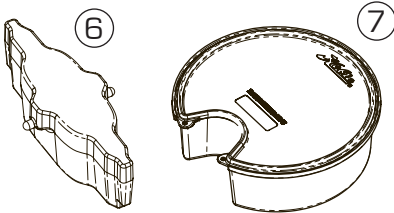
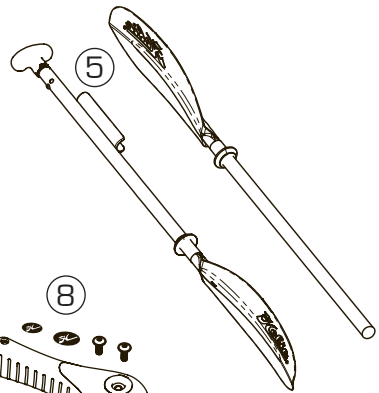
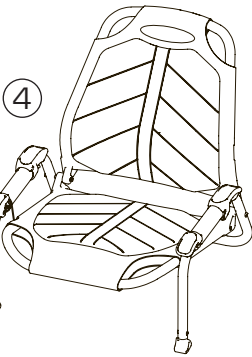
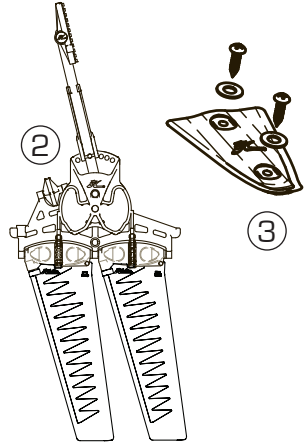
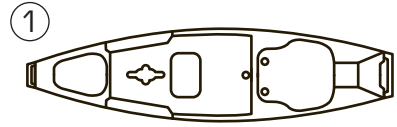

Steering Handles

The steering handle and steering knob can be installed on either the right or left side per your preference

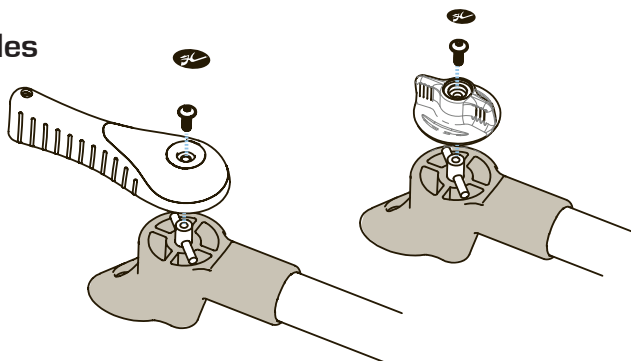

MirageDrive Cranks

①

Insert cranks into drums

②

Tighten crank bolt using a 9/16" or 15mm wrench

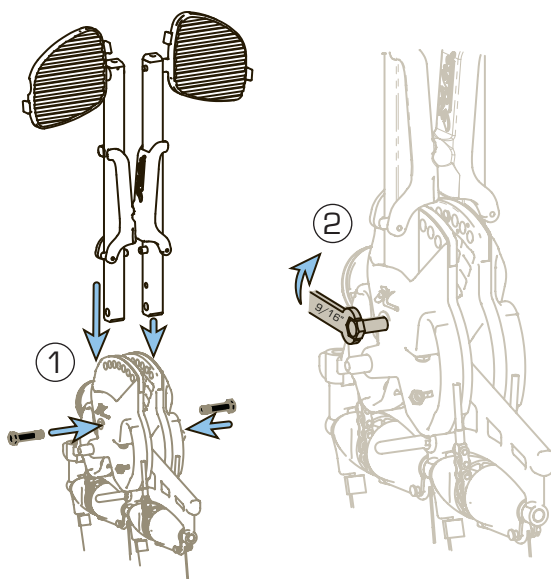

MirageDrive Seal

Installing the drive seal is a helpful feature and reduces water surge up the well. Pay special attention to installing the drive correctly if the seal is installed.

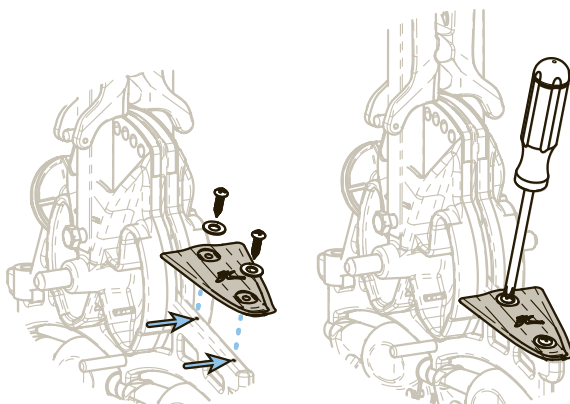

Tackle Management Rack Removal

①

Twist handle counter-clockwise

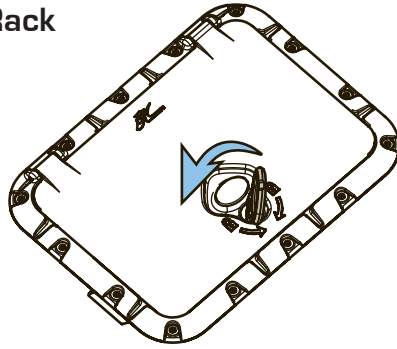

②

Open lid

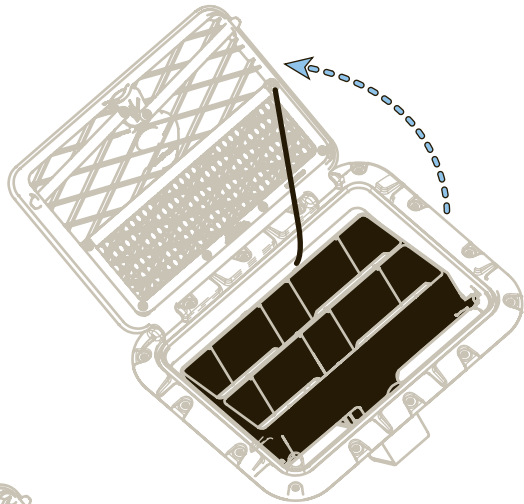

③

Press rack to the side to clear the detent and lift out

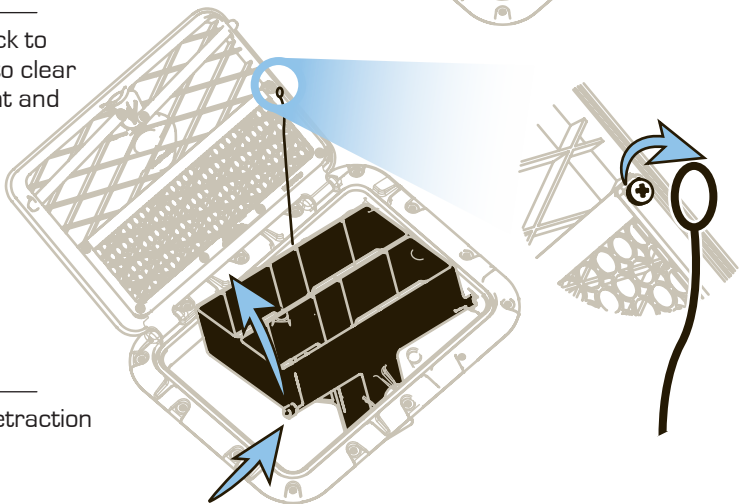

④

Unloop retraction line

Installation

①

Lower drive straight down making sure the spine is level

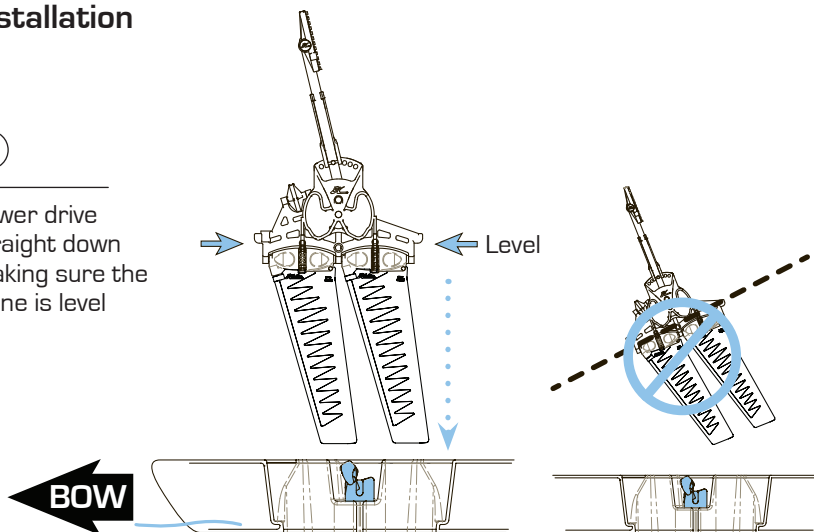

②

Press down and lock drive into Click and Go's

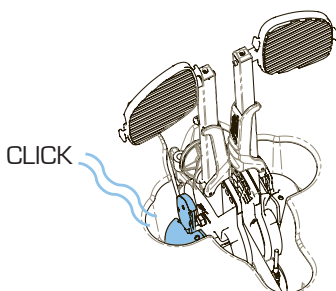

Removal

①

Pull back each Click and Go lever

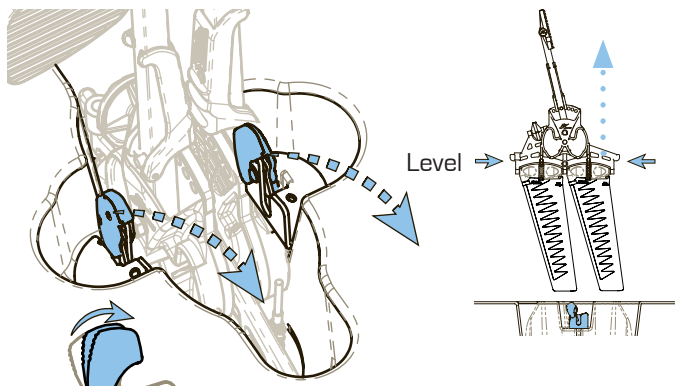

②

Lift drive straight up



Pedal Adjustment

①

Squeeze adjuster handle

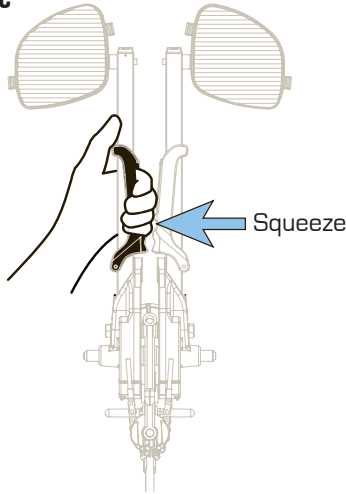

②

Adjust cranks to desired position by rotating and clicking them into the desired position. Make sure both cranks are in the same position number.

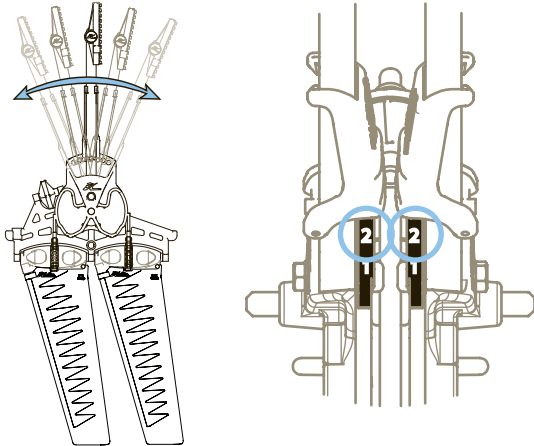

③

With both feet on the pedals and together (fins straight down), your knees should be comfortably bent and not over crunched or extended.

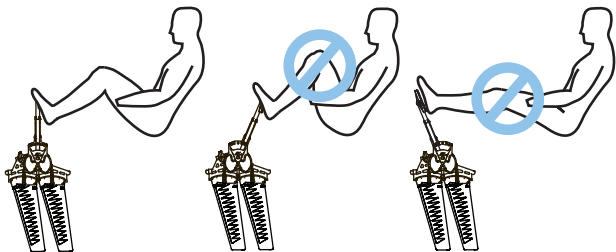

Installation

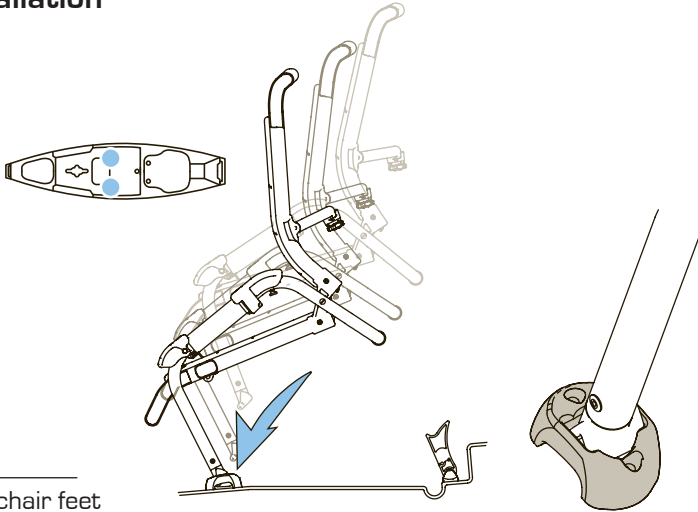

1

Lock chair feet to boat

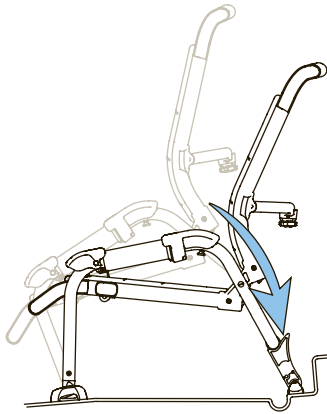

2

Pivot chair onto kickstand

3

Place webbing strap over pin on the seat frame and hook clip

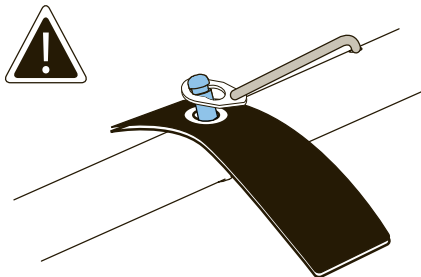

Lowering



①

Shift weight forward and tilt seat up

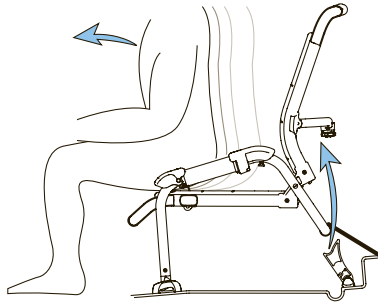

②

Pull and hold seat handle

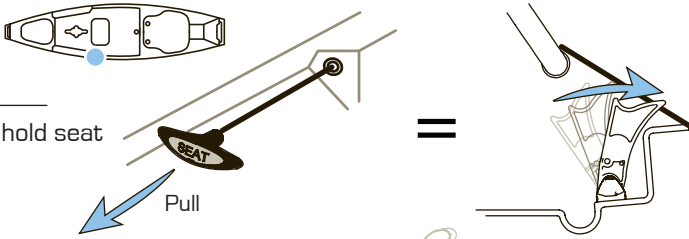

③

Lean back to lower seat down

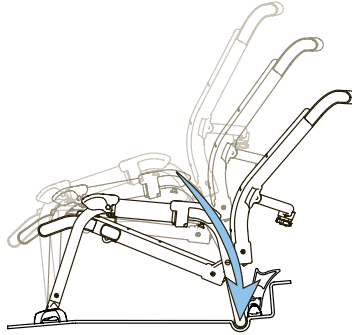

Raising

①

Shift weight forward and tilt seat up

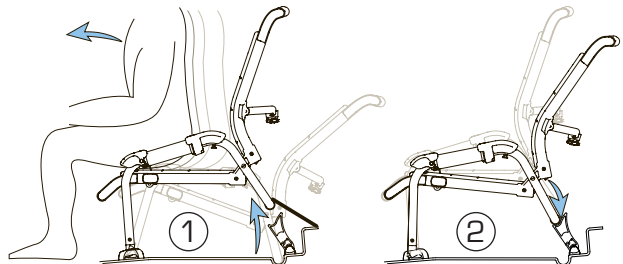

②

Lean back to lower seat onto kickstand

Back and Bottom Adjustment



①

Slide adjuster grip forward

②

Rotate grips to adjust seat

③

Make sure adjuster grip locks securely

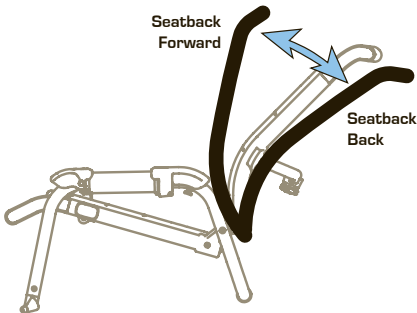
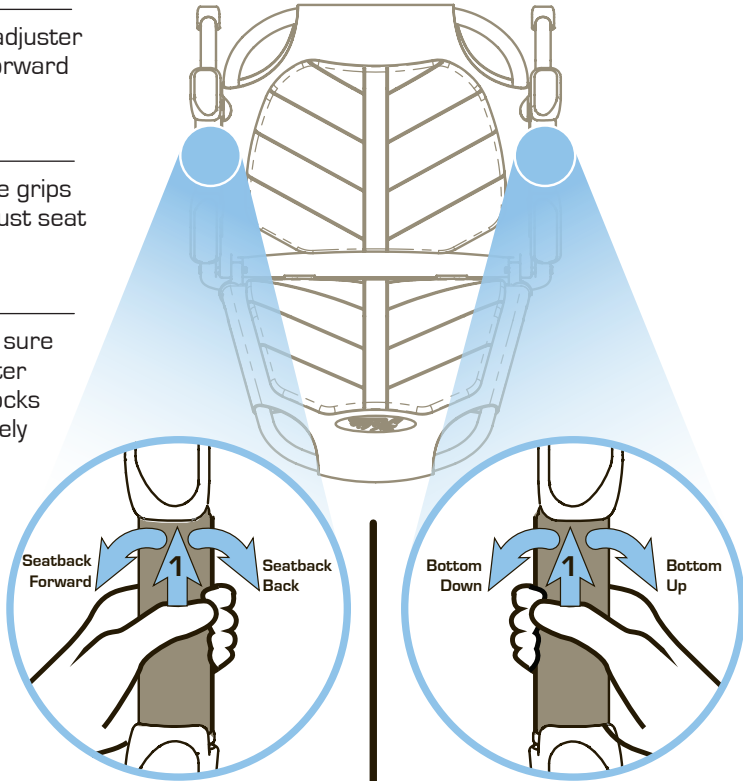

Lean forward to make seat back adjustment easier

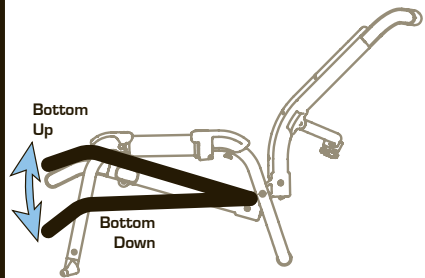

Ease weight off of seat to make adjusting seat bottom easier

Lumbar Adjustment

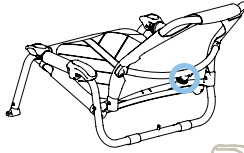

1

Pull knob to release lumbar

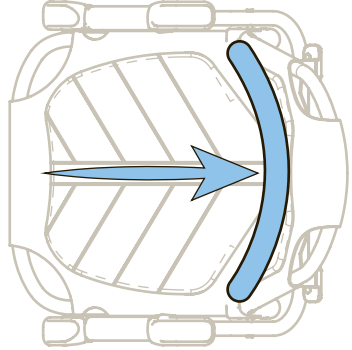
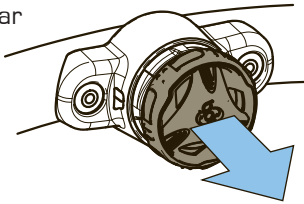

2

Press knob to lock lumbar

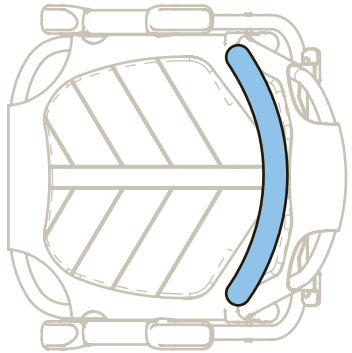
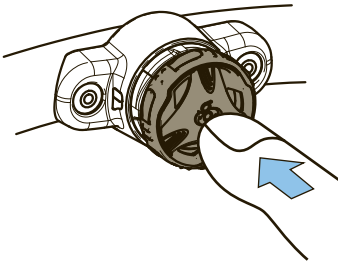

3

Rotate knob to tension lumbar

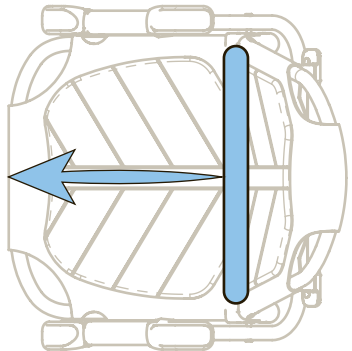
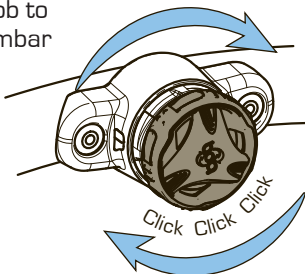

MirageDrive Operation

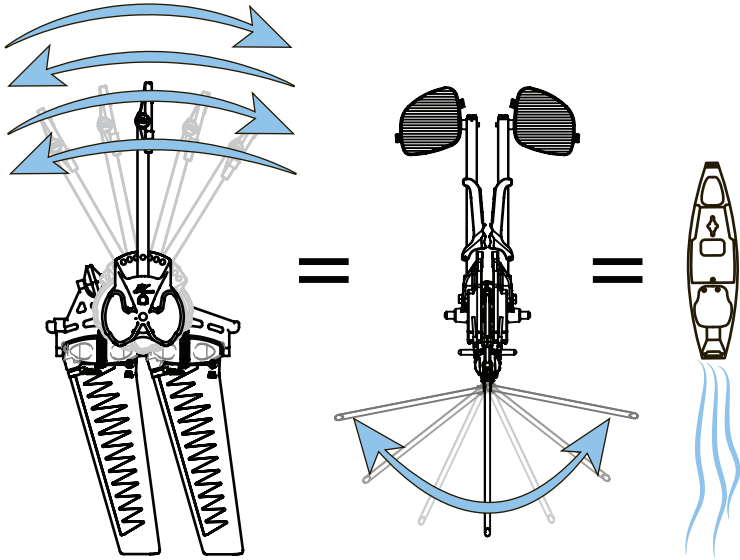

Shallow Water

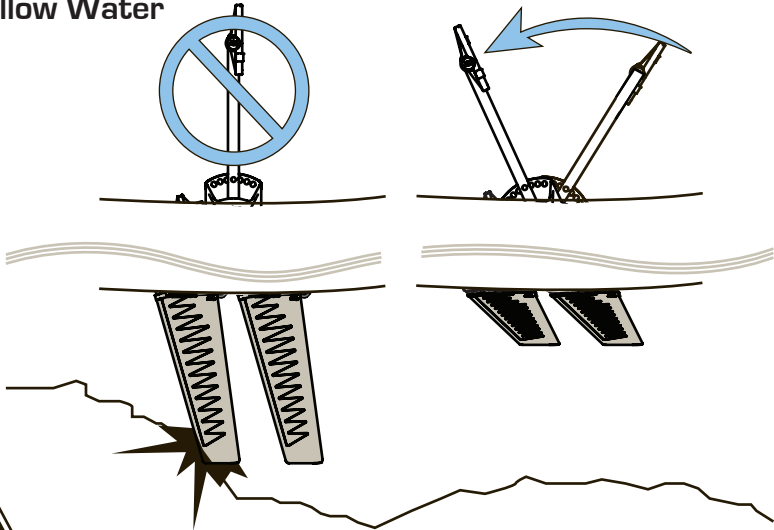

Press either pedal forward in shallow water to raise fins

Rudder Down and Up

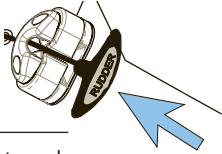

Uncleat and release

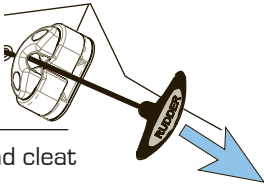

Pull and cleat

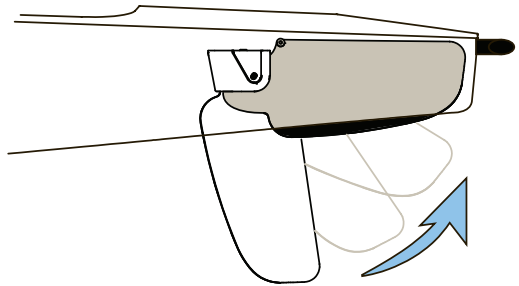
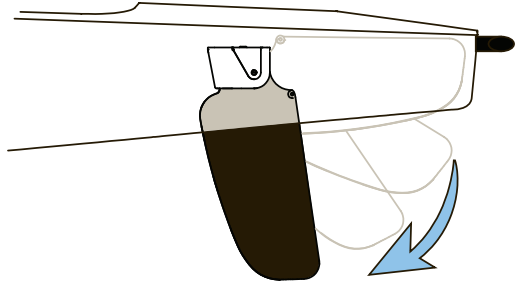

Steering

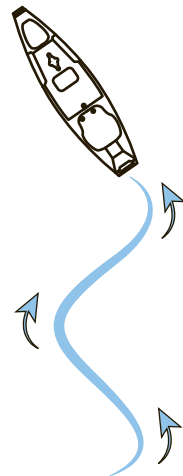
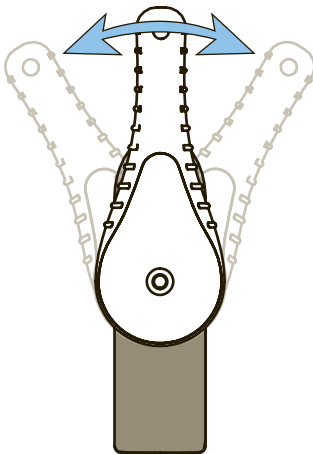

Underseat Strap

Use strap under seat to hold down tackle boxes

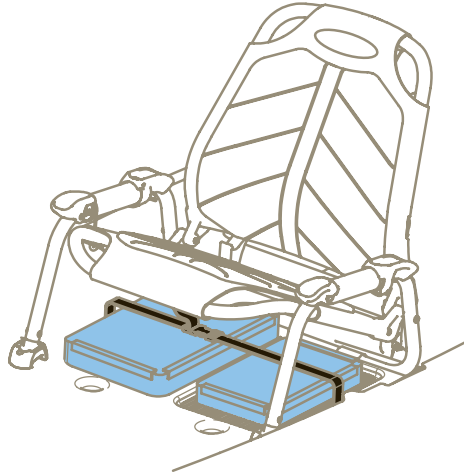

Use this same strap to hold down seat during transport

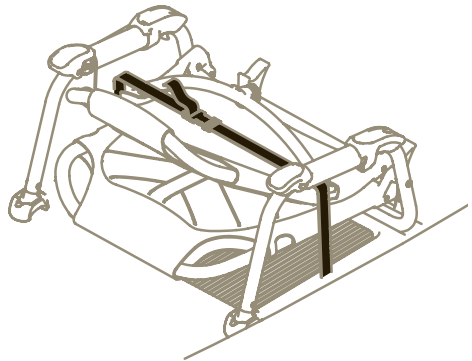

Paddle Storage

Clip the paddle to the side rails for storage. Wrap the velcro around the tube for extra security

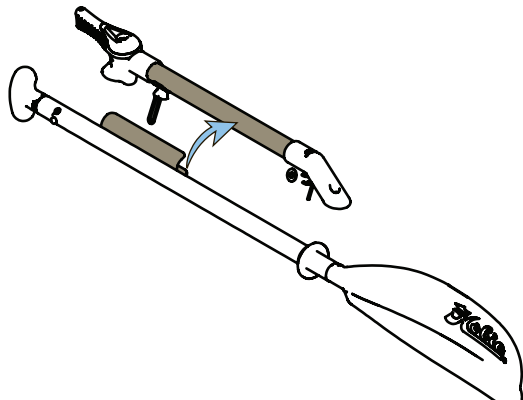

Transducer Installation

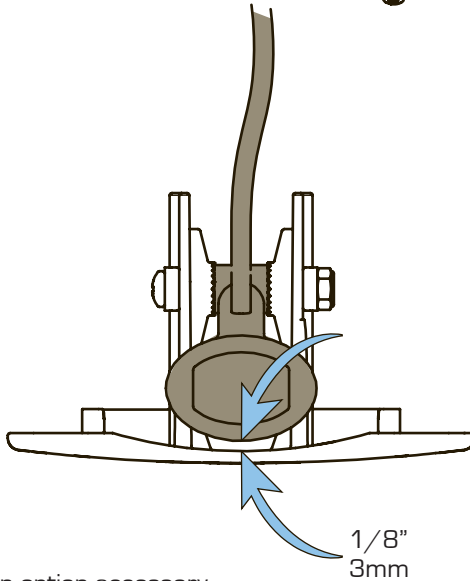
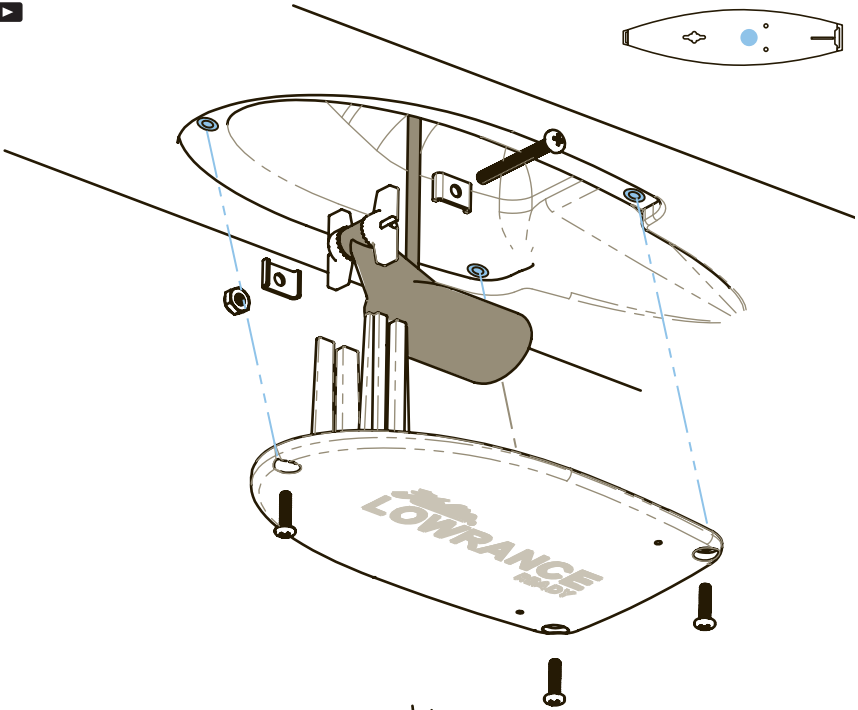

Transducer is an option accessory and is not included with boat

Thru-Hull Plugs

①

Locate the thru-hull plug and unscrew the nut on the inside of the boat

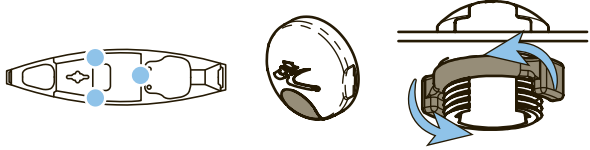

②

Remove the solid rubber plug

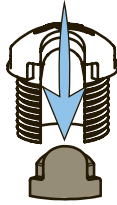

③

Choose the correct plug for your wire size and insert the wire by opening the plug along the slit

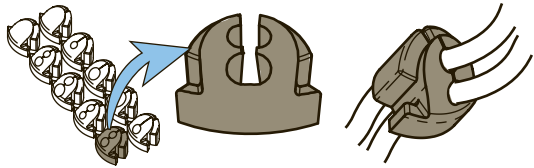

④

Press the new plug with the wire installed into the plastic plug making sure it fits properly

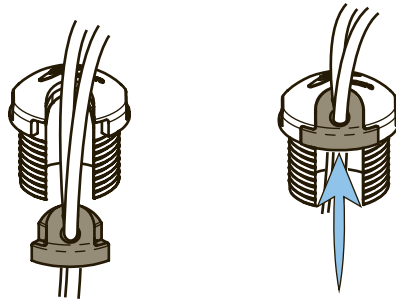

⑤

Bolt the thru-hull wire assembly to the hull using the nut, and making sure you have the o-ring installed

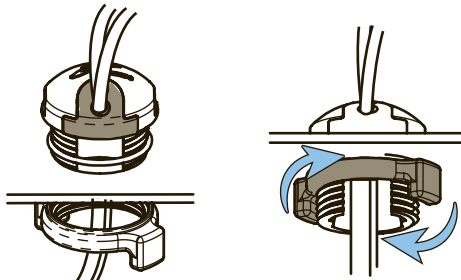

Wire Installation



①

Run the cable into the plug just behind the transducer scupper

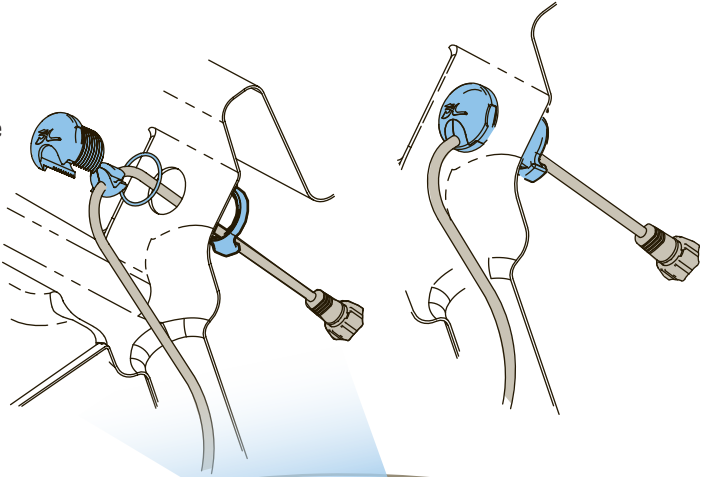

②

Lead the cable up underneath either side of the mounting boards and out through the thru-hull fitting

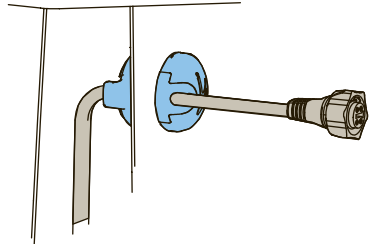
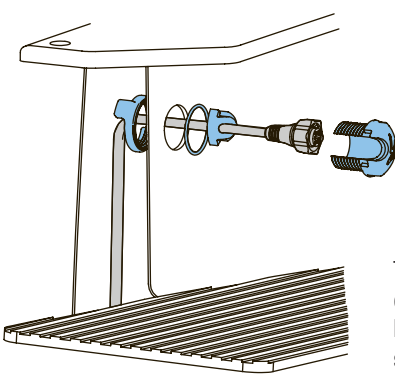
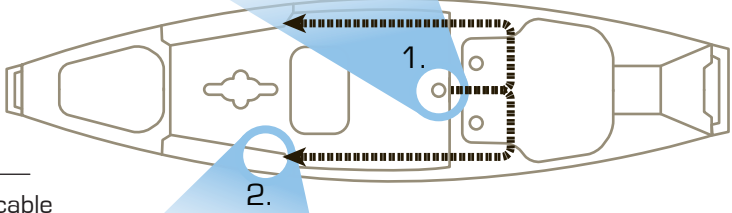

There are plugs for the wire to come out on either side of the boat if you prefer a right/left side screen location.

Storage Do's

Storing your boat upright with properly fitting cradles is most advised

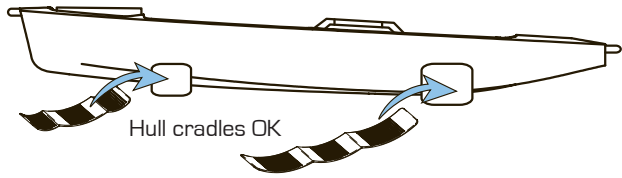

Storing your boat upside down on crossbars or hanging from wide strapping are two other great ways to keep the boat stored

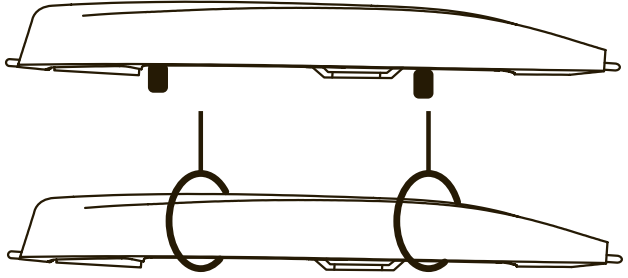

Storage Don'ts

Storing your boat cockpit side up on crossbars can dent the bottom

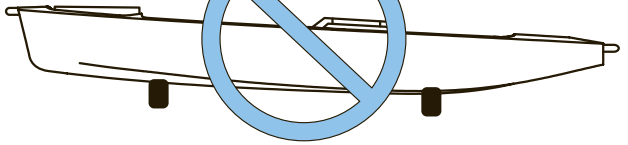

Storing your boat on its side over a long period of time can flatten/dent the sides.

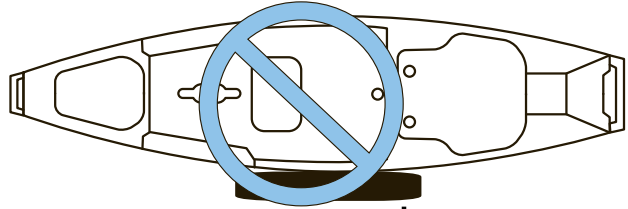

Hanging the boat by the scuppers can distort the scupper holes.

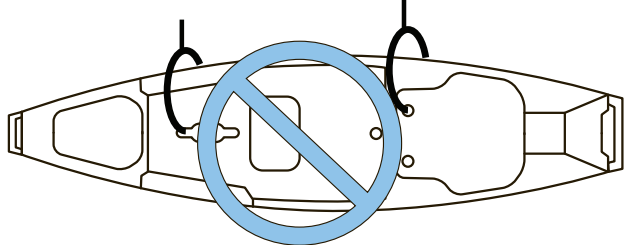

Never hang the boat by handles or pad eyes. They are not designed to handle long term load and will fail.

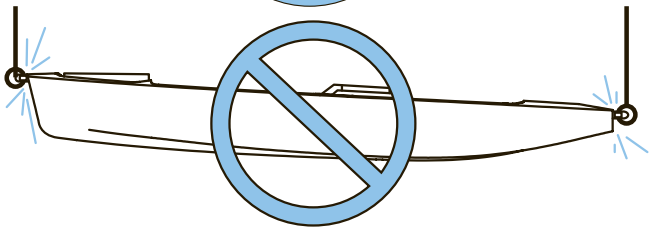

Additional Storage Key Points

- Always remove all water from boat
- Don't leave tie down straps tight over a long period of time
- Storing in non-recommended configurations can result in hull damage and can void your warranty
- Never hang from the handles or padeyes

Cart

The cart should be used for transportation purposes only and not as a storage platform. Do not leave your boat on the cart for more than one hour (less time in warmer temperatures or direct sunlight).

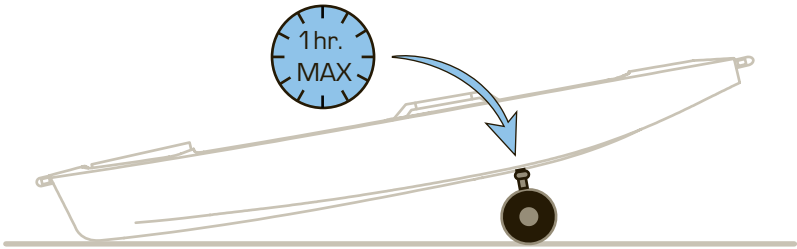

Store out of Weather

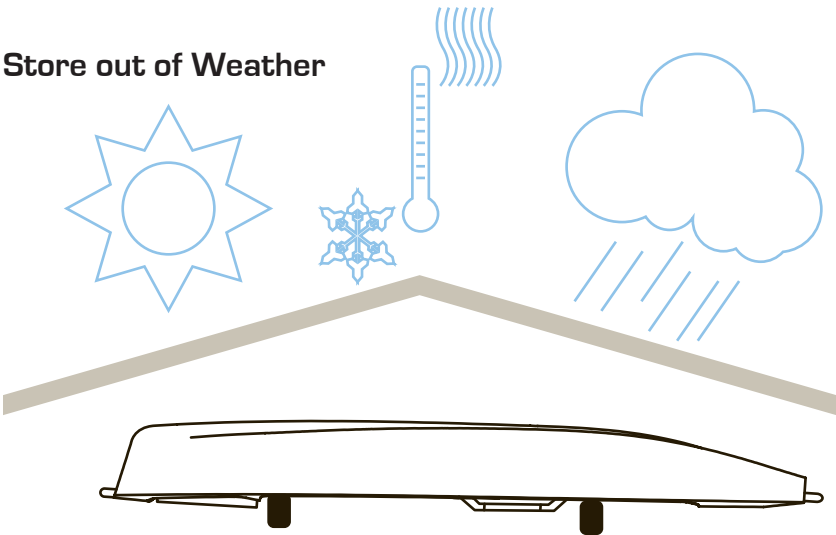

Roof Topping

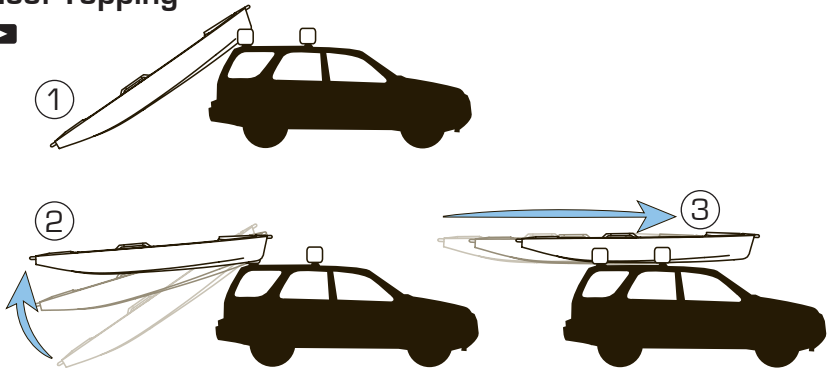

The best way to transport your boat is to purchase a trailer or roof rack from your dealer. Using proper cradles that support the hull, the boat can be transported right side up. Straps can then be laid across the boat and tied to the bars. Straps should be tight, but not so tight that they distort the shape of the boat. Avoid using ratchet straps to prevent overtightening.



Be sure to first consult your car and roof rack owner's manual to ensure that you comply with all of their recommendations, precautions and specifications.

Running a line or strap from the bow and stern of the boat to each bumper is required. If your bumpers do not have a gap to pass a rope around, look underneath. There should be a loop of metal, which is used by car transports such as tow trucks.

Many people like to use the scupper holes to tie the boat to the car. This helps prevent the boat from sliding back and forth or the tie-down rope from slipping off the boat. (This is an acceptable method for tying the boat down for transport.)

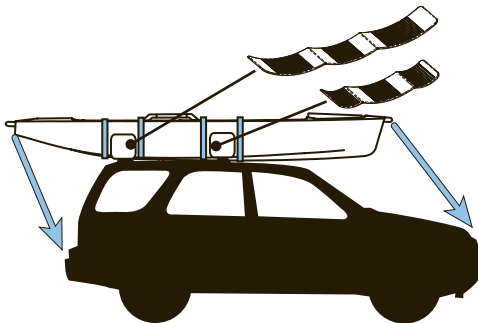

MirageDrive Regular Maintenance

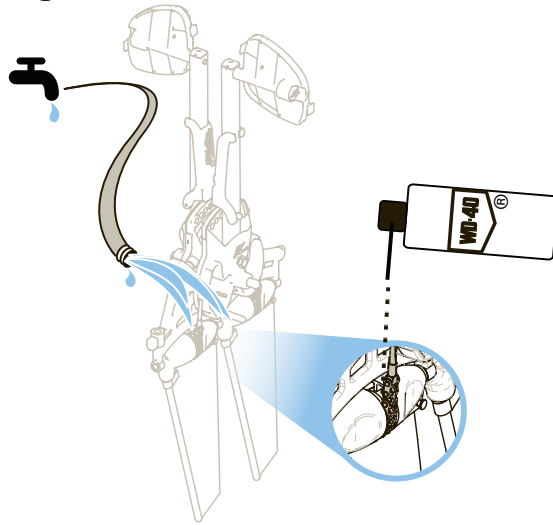

Checking Cable Tension

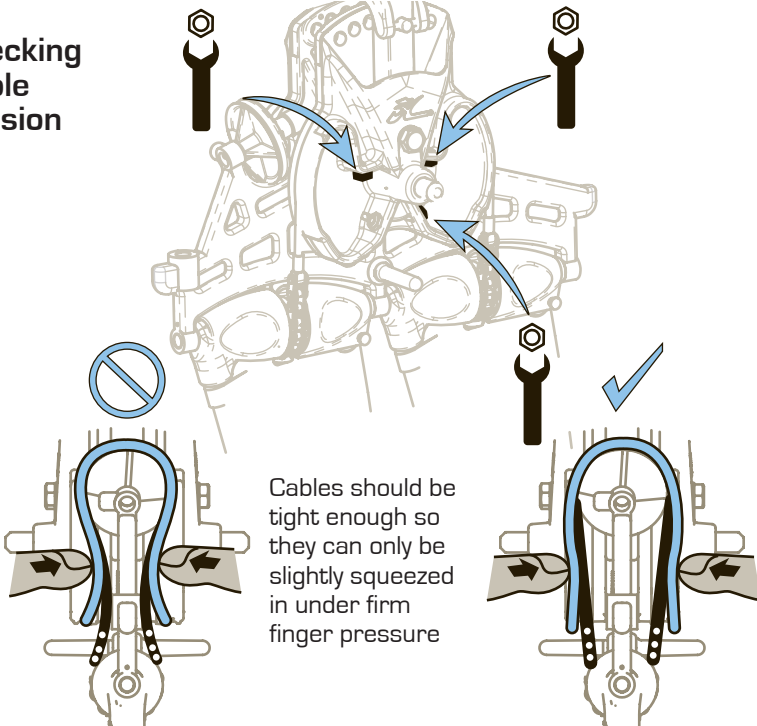

Visit the support section at hobiecat.com for information on the MirageDrive.

Rudder Tuning

①

Pull up rudder

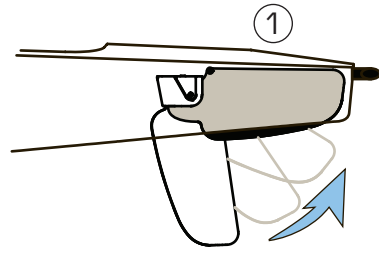

②

Remove rudder cover

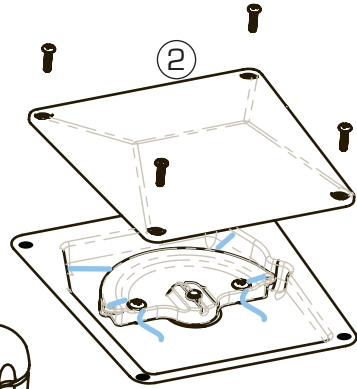

③

Loosen the screw clamping the rudder line

④

Pull the slack out of the rudder line making sure that the steering handles are still straight. If they are not straight, adjust the lines accordingly.

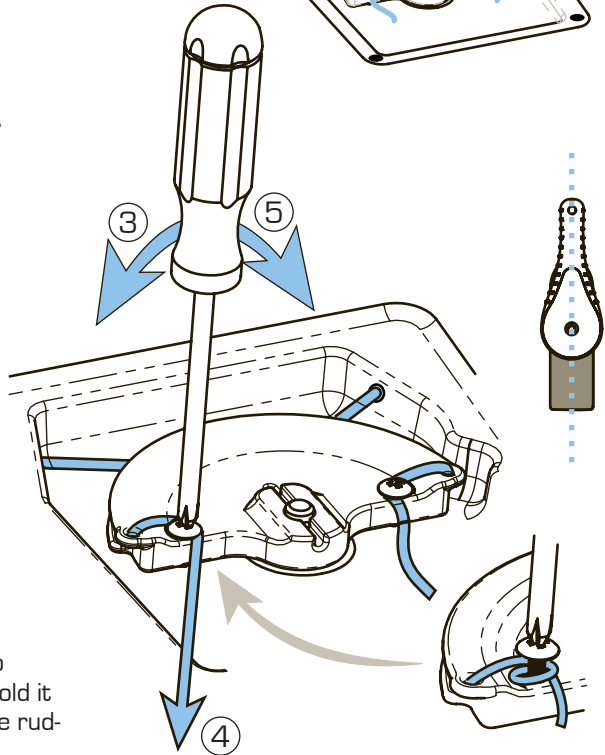

⑤

Tighten the screw to clamp the line and hold it in place. Replace the rudder cover.

Checklist

Please read through the owners information package prior to using this product.

The user of this product acknowledges both an understanding and assumption of risk involved in paddle/pedal sports. Consult your physician prior to beginning.

Always:

- Wear a Coast Guard approved personal flotation device
- Dress appropriately for weather conditions; cold water and/or weather can result in hypothermia; apply sunscreen and other sun protective clothing
- Check your equipment prior to each use for signs of wear or failure
- Tie a leash to your paddle and MirageDrive
- Scout unfamiliar waters
- Be aware of river water levels, tidal changes, wind conditions, obstacles in and above the water and weather changes
- Always make sure that your hatches are secure
- Carry a pump and/or bailing device
- Always carry the spare paddle provided with the boat

Never:

- Never go alone and always file a float plan
- Never go in flood and/or fast moving water conditions. Hobie kayaks are not designed for fast moving water.
- Never exceed your ability and be aware of your limitations
- Never use alcohol or mind-altering drugs prior to or while using this product
- Never open your hatches in unstable water conditions
- Never remove the foam pieces inside the hull. They are installed for structure, additional flotation and safety reasons.

Shakedown Cruise

As with any new product, it is important that you become familiar with the boat and all its features. It is also important to determine if the boat is sound before long trips. We recommend that you do what we call a “shakedown cruise” when the boat is new, after shipping or transport, before long trips and after installing any thru-hull fittings. This test is typically done in shallow, calm conditions where you can familiarize yourself with or test the boat before taking any long trips into open water. Things that you should check or practice are:

- Rudder operation
- MirageDrive installation, adjustment and removal
- Getting in and out of the boat from a capsized state
- Drain plug locations to make sure they are properly installed
- Closing hatches properly
- Taking the kayak sail down on the water (if applicable)

Getting into your Boat

Falling out of your boat is something that very rarely happens, but it is important to practice and prepare for this type of situation. We recommend that you try climbing into your boat in a pool or shallow water to improve your technique. We recommend that you enter your boat from the side or back of the boat depending on conditions.

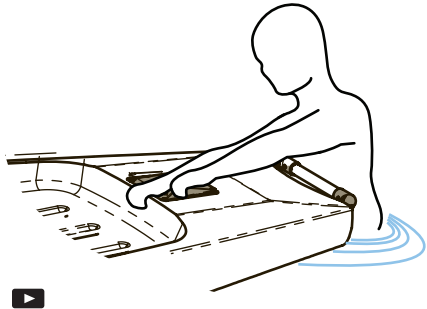

Mirage Cassette Plug

You Hobie is shipped with a Mirage Cassette Plug. The plug is provided as standard equipment in the Mirage Kayak package. Insert the plug into the Mirage well when the MirageDrive is removed to provide added safety and to “fair” the bottom of the hull when paddling.

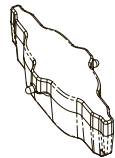

Kayak Sail Safety

The kayak sail is a very popular optional accessory that works really well with Hobie Mirage kayaks. It is important to familiarize yourself with the use of the sail and how wind power affects the stability of the boat. The sail is not recommended to be used in wind conditions over 10 MPH.

It is very important that you complete and send us your Warranty Registration Card as soon as possible. This information enables Hobie Cat Company to contact you should there be important product information that needs to be shared with you in a timely manner. Please complete the Warranty Registration Card in your Owner's Packet, or take advantage of our hassle-free online option at:

<http://www.hobiecat.com/support/warranty-registration/>

or

Scan this QR code with your smart phone



If you have a problem or question with your Hobie product, please see your Authorized Hobie Kayak Dealer. They will be able to assess the problem, assist with a repair and file a warranty claim with Hobie Cat Company if needed. All warranty claims must go through your Authorized Hobie Kayak Dealer. The Warranty Registration Card and Warranty Policies are included with each model in the Owner's Packet. Type in the address below to go to our dealer finder webpage.

<http://www.hobiecat.com/support/dealers/search/>

Enjoy the Ride!

Hobie Cat Company
Oceanside, California, USA
1-800-HOBIE-49
hobiecat.com

Hobie Cat Australasia
Huskisson, New South Wales Australia
1-800-4-HOBIE
hobiecat.com.au

Hobie Kayak Europe
Stellendam, The Netherlands
+31(0)187 499 440
hobie-kayak.com

